

**1949
(U-BRACKET 1-1/4")**

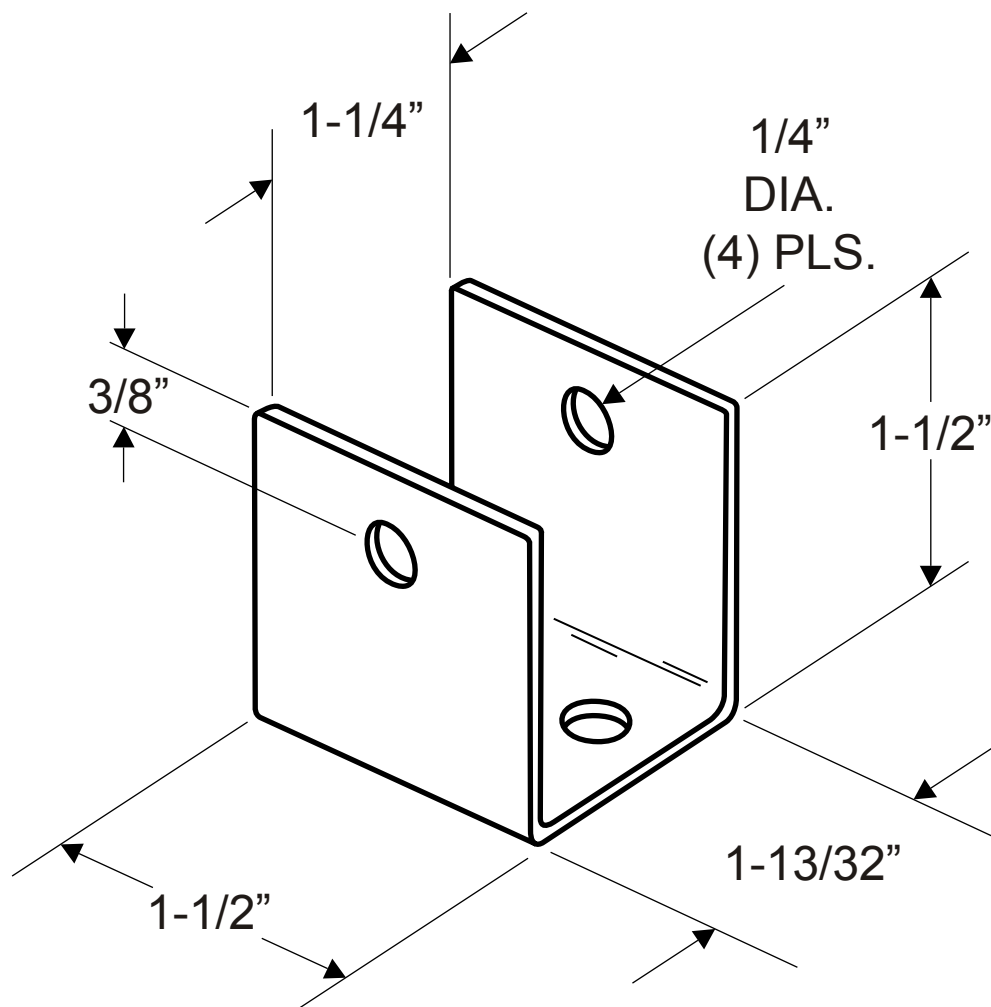

**NOTE: 14 GAUGE (.075" THICK STAINLESS)
TWO HOLES IN BASE**